

SCIENTIFIC DATA SYSTEMS, INC.

CPF Panel Connection Quick Reference

Panels Connection Quick Reference

Pin Out Connectors

DEPTH CABLE

Depth Panel 7 Pin Female

Interface Panel 7 Pin Male

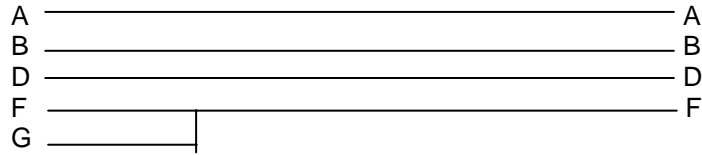

ENCODER CABLE

7 Pin Male

Depth Encoder 7 Pin Female

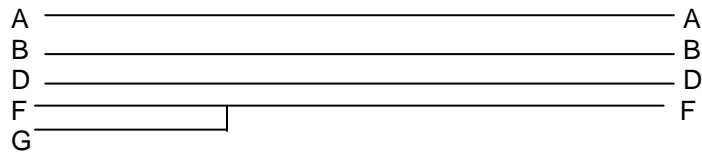

TENSION CABLE

Depth Panel 5 Pin Female

Interface Panel 5 Pin Male

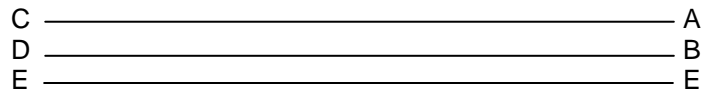

TENSION TRANSDUCER CABLE (XPRO-HONEYWELL PRESSURE TRANSMITER)

5 Pin Male

Pressure Transducer

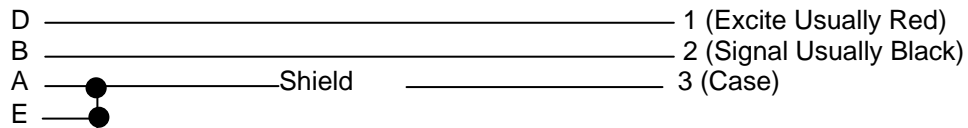

TENSION TRANSDUCER CABLE (ASCO PRESSURE TRANSMITER)

5 Pin Male

Pressure Transducer

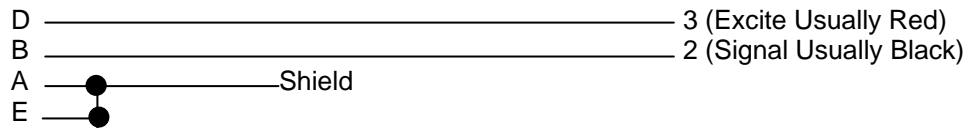

DC CABLE 12V DC

3 or 2 Pin Male

Battery Truck (12 VDC)

A	_____	Positive
B	_____	Negative
C	_____	NC

LIGHTS CABLE

4 Pin Male

Lights

A	_____	Common
B	_____	RED Light
C	_____	GREEN Light
D	_____	NC

ISO ADAPTER BOX

P1 (TENSION TRASDUCER CABLE)

4 Pin Male

Pressure Transducer

A	_____	(- Signal In)
B	_____	(+ Signal In)
C		
D		

P2 (ISO TENSION TRASDUCER CABLE)

3 Pin Male

Depth Panel 5 Pin Female

A	_____	B(+ Signal Out)
B	_____	D(- Signal Out)
C		

P3 (DC CABLE 12 V DC)

2 Pin Female

Battery Truck (12 VDC)

A	_____	(+12 VDC)
B	_____	(GND)

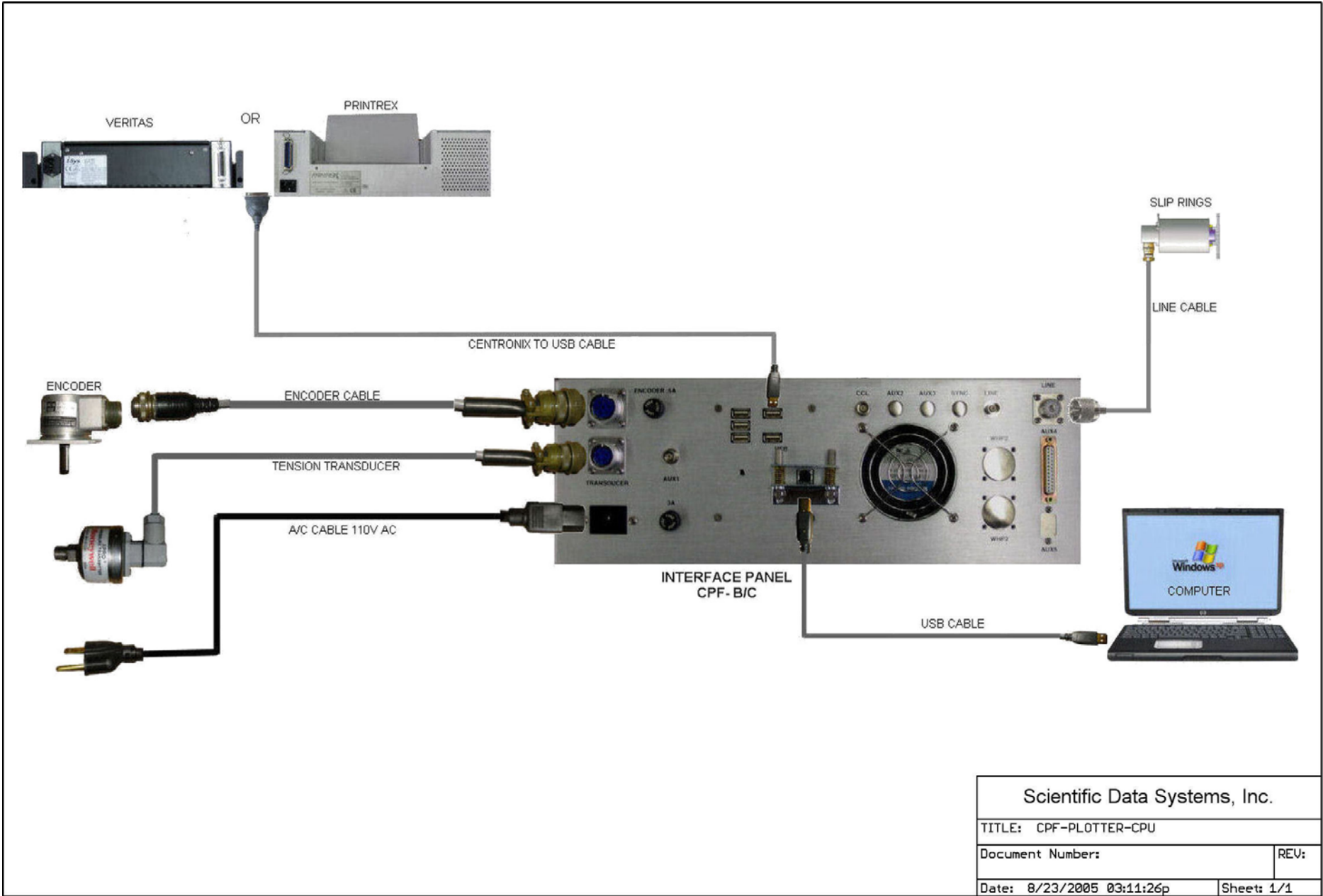

Scientific Data Systems, Inc.	
TITLE: CPF-PLOTTER-CPU	
Document Number:	REV:
Date: 8/23/2005 03:11:26p	Sheet: 1/1

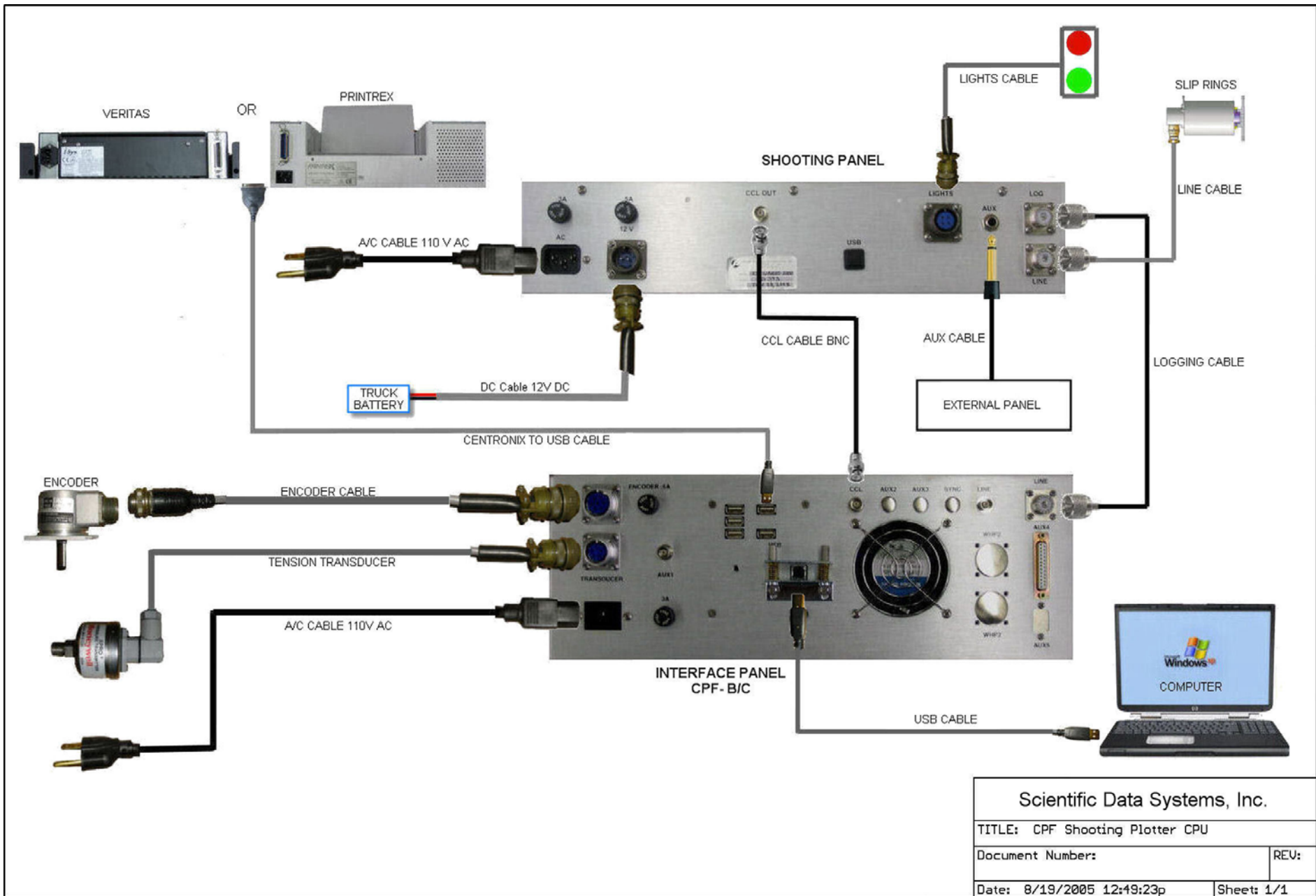

Scientific Data Systems, Inc.	
TITLE: CPF Shooting Plotter CPU	
Document Number:	REV:
Date: 8/19/2005 12:49:23p	Sheet: 1/1

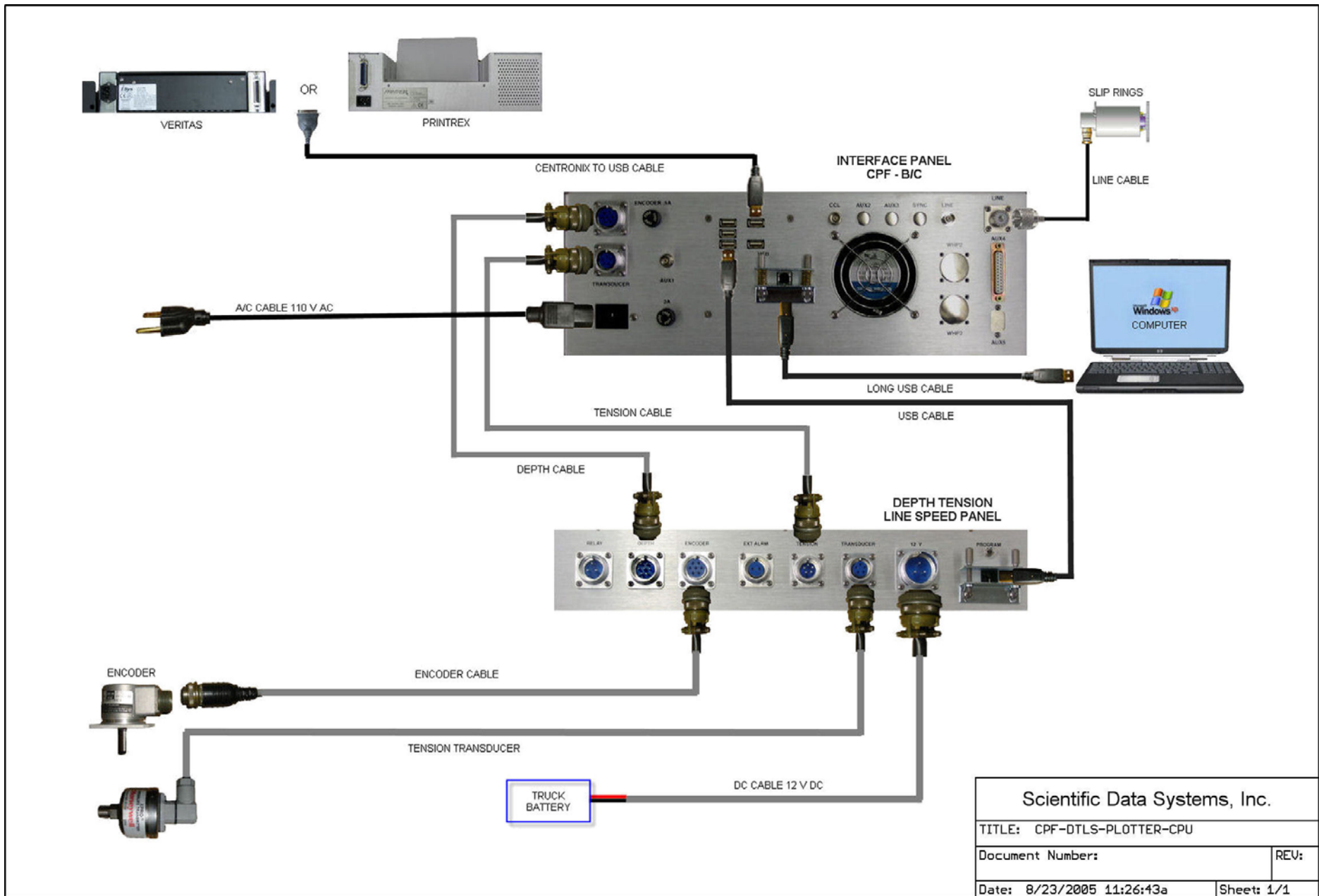

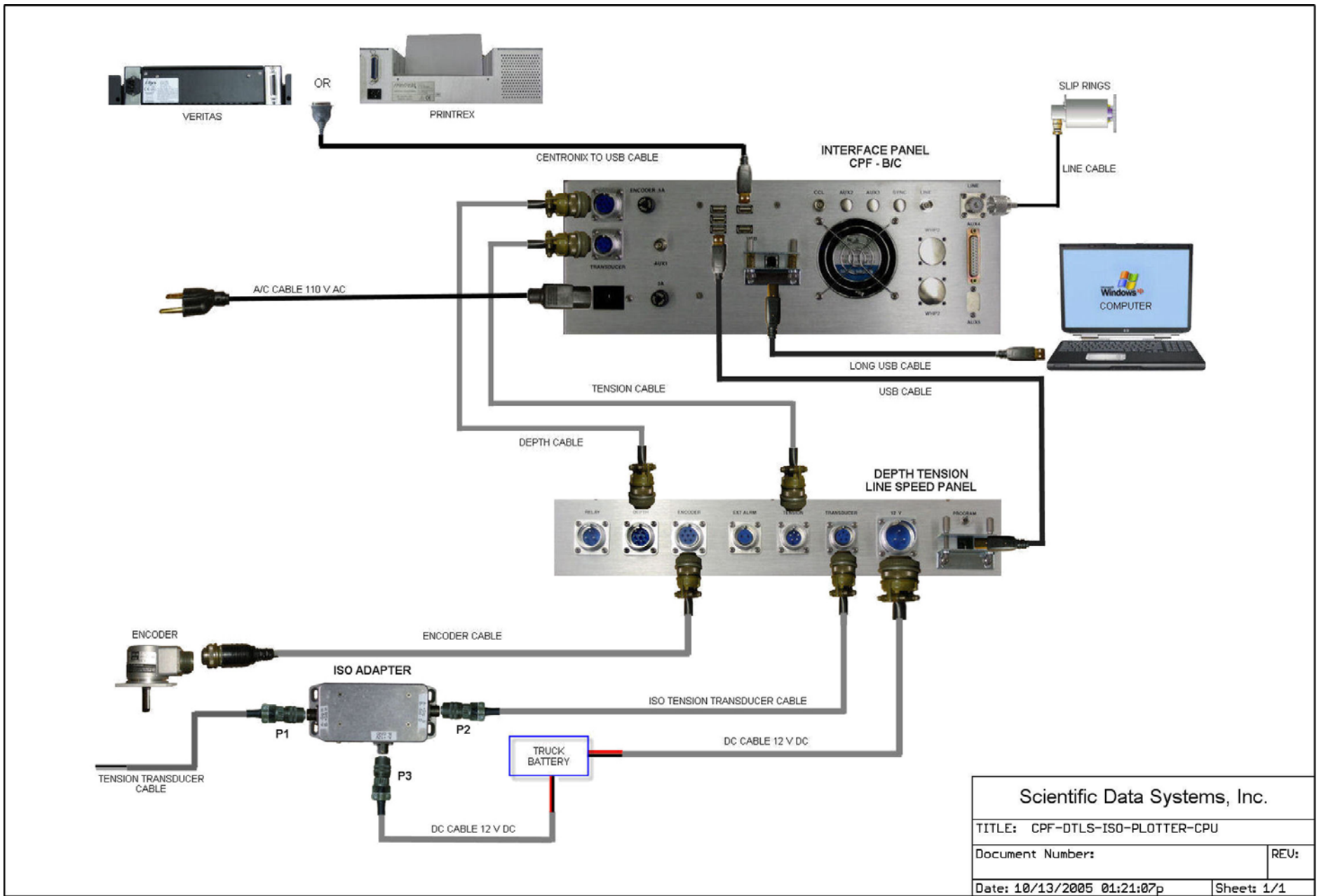

Scientific Data Systems, Inc.	
TITLE: CPF-DTLS-ISO-PLOTTER-CPU	
Document Number:	REV:
Date: 10/13/2005 01:21:07p	Sheet: 1/1

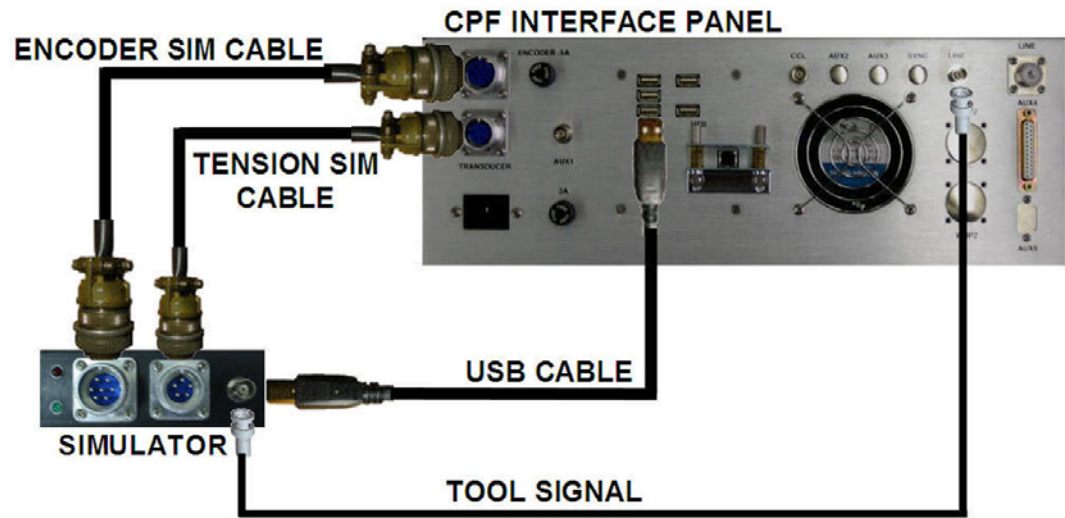

Scientific Data Systems, Inc.	
TITLE: Simulator Box	
Document Number:	REV:
Date: 1/30/2006 02:41:30p	Sheet: 1/1

Printer Installation

PRINTREX INSTALLATION IN WINDOWS XP

Prior printer installation, it is recommended to upgrade the Windows XP from the Internet.

- 1) Install the printer in windows XP. The CD warrior software must be in the CD Device
- 2) Plug in Belkin USB Printer Adapter cable into any available USB port
- 3) **Do not remove the Belkin USB printer from the chosen USB port**
- 4) **Do not plug in the USB printer adapter to a different USB port**
- 5) Select settings/Printers and Faxes

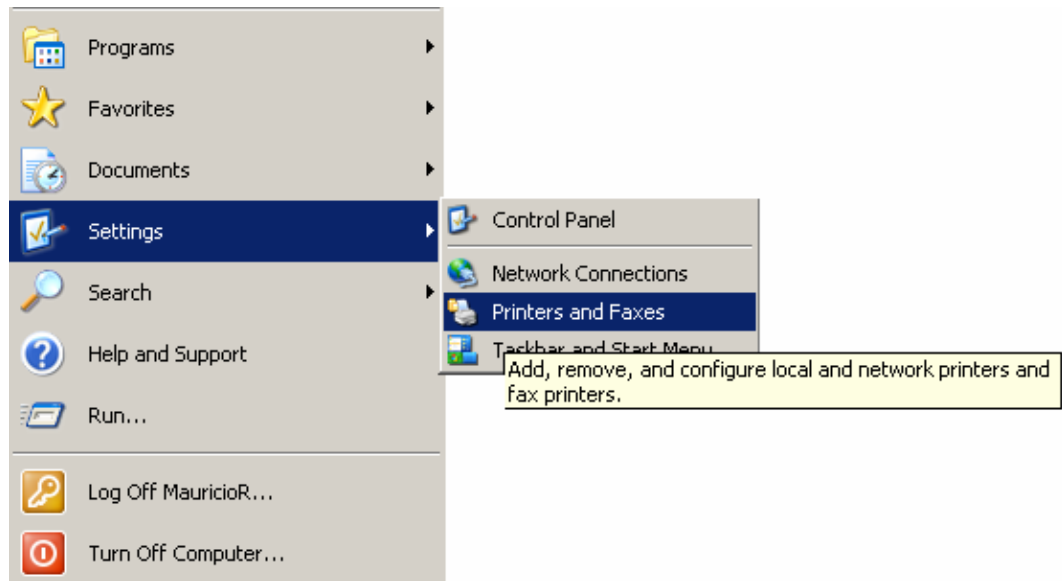

- 6) Add Printer

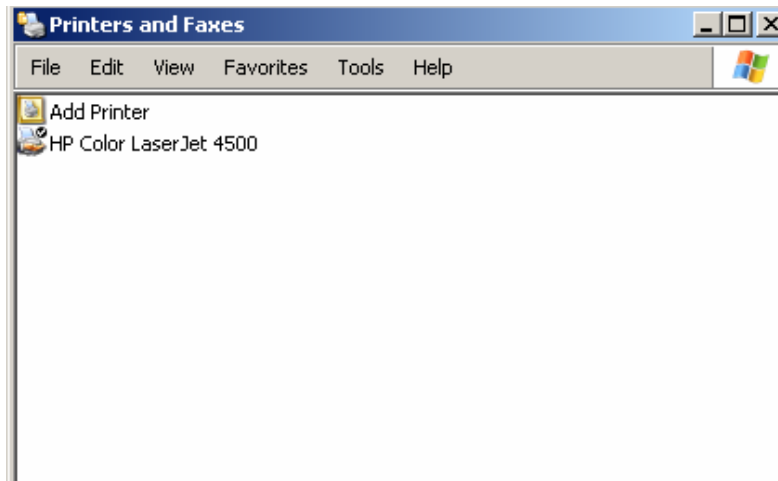

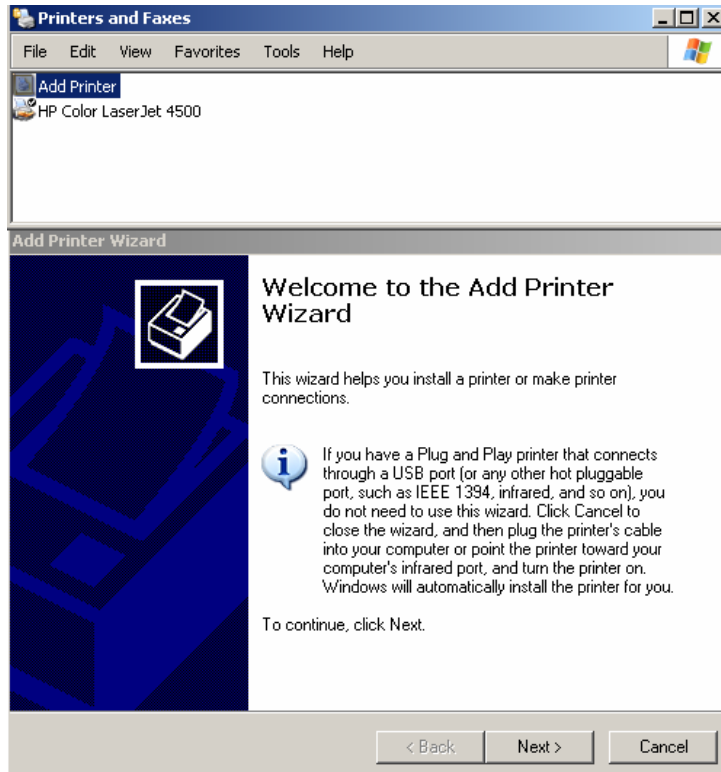

7) Select Next

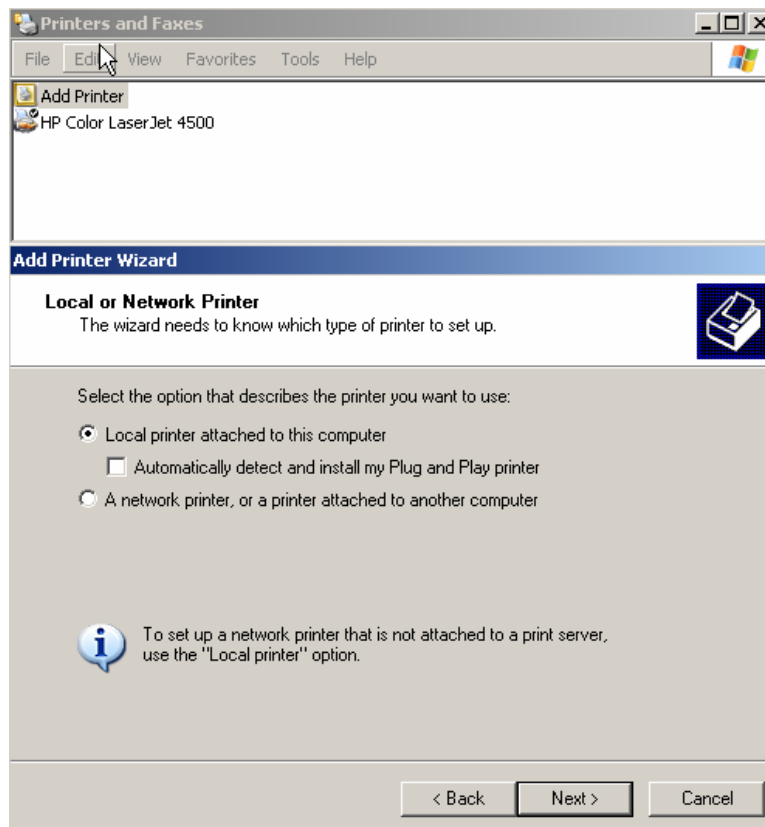

8) Uncheck (Automatically detect and install my Plug and Play printer) and Select Next

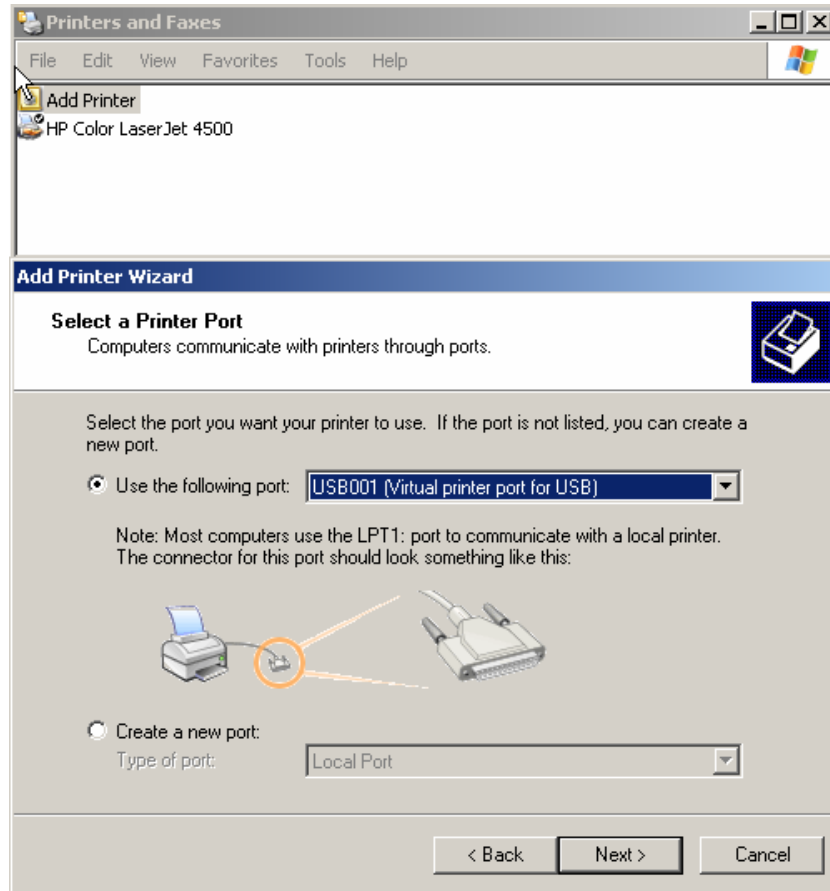

- 9) Select Printer Port if it is the first printer you connect to the USB. Select USB001 and then select Next

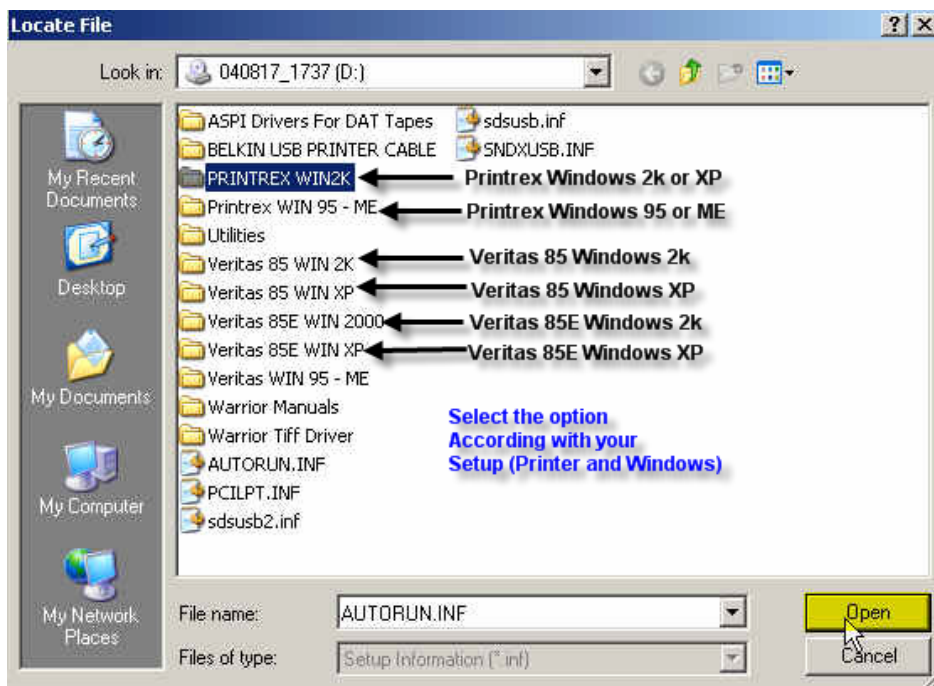

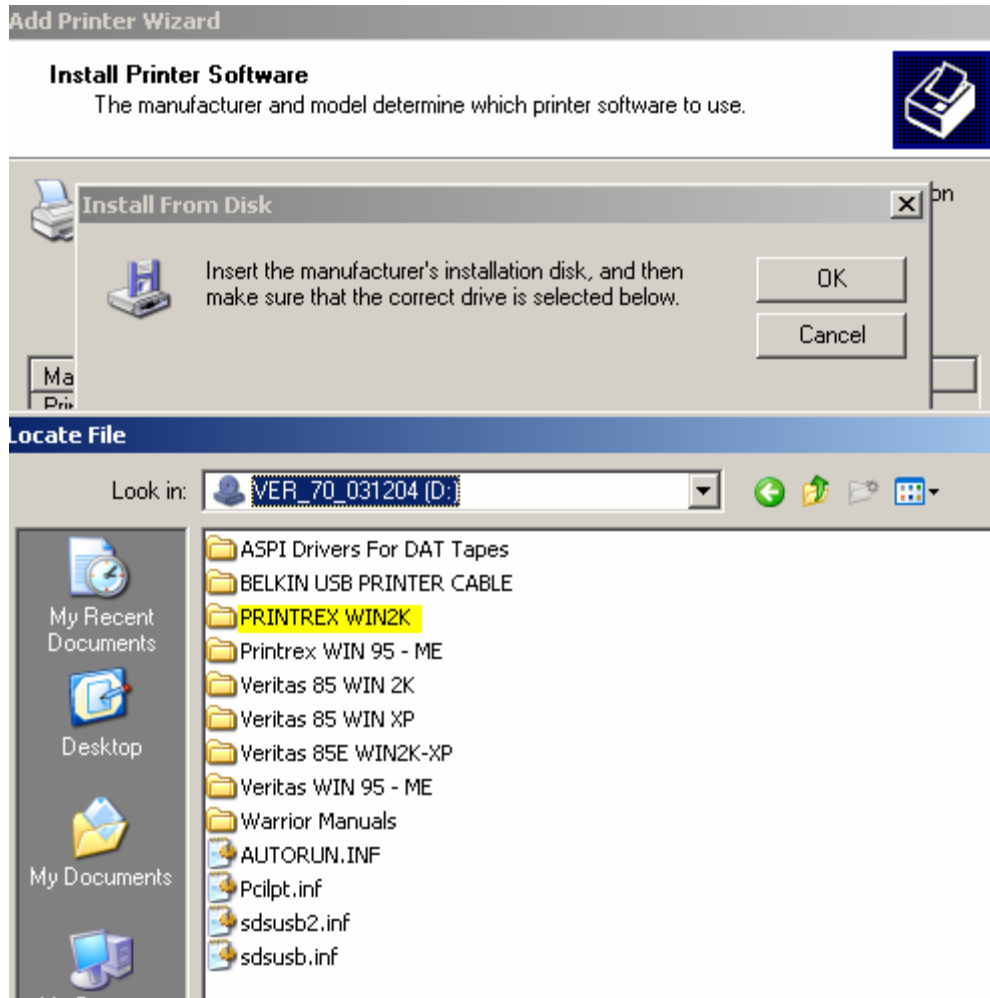

10) Select the Driver Printrex WIN2K is the driver to install in Win2K/ XP.

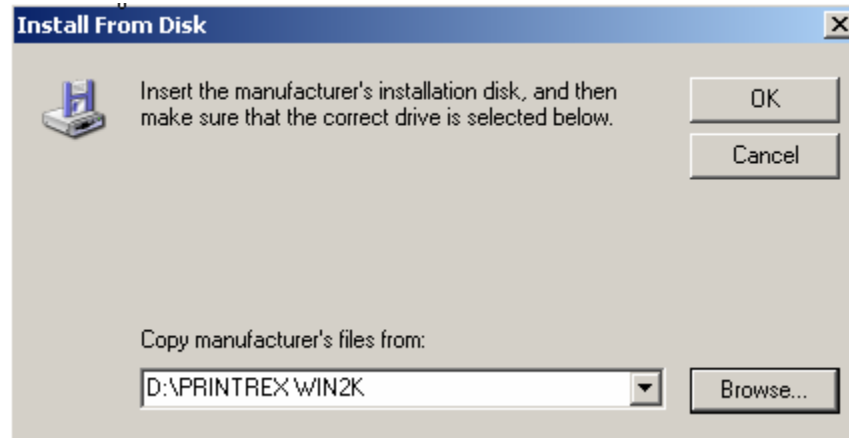

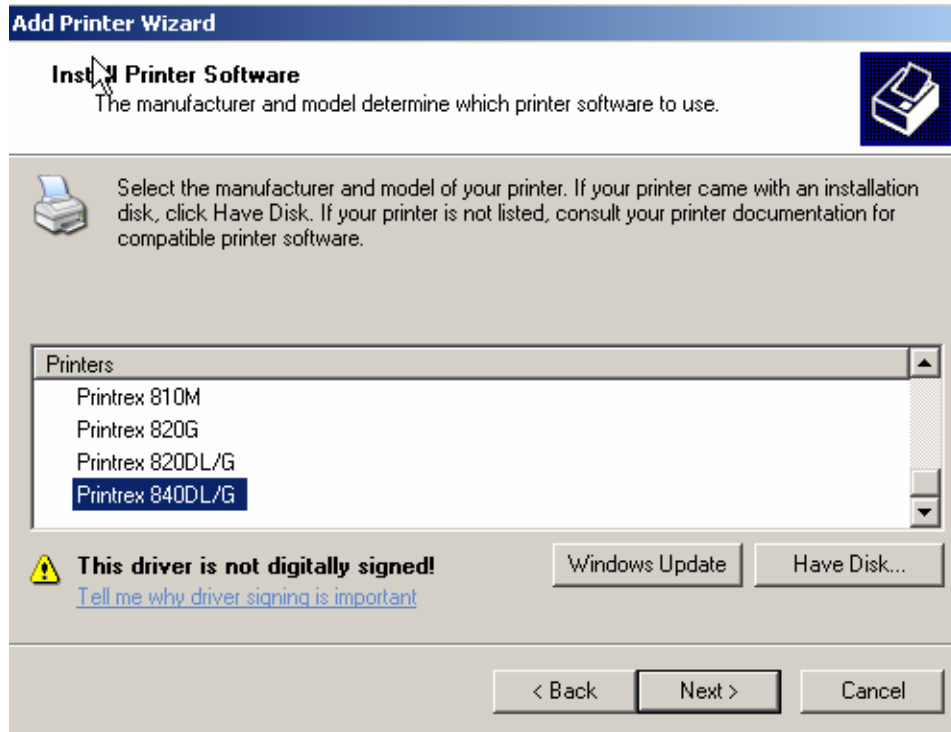

11) Select the Model Printrex 840DL/G or the Printrex Model you have in your system

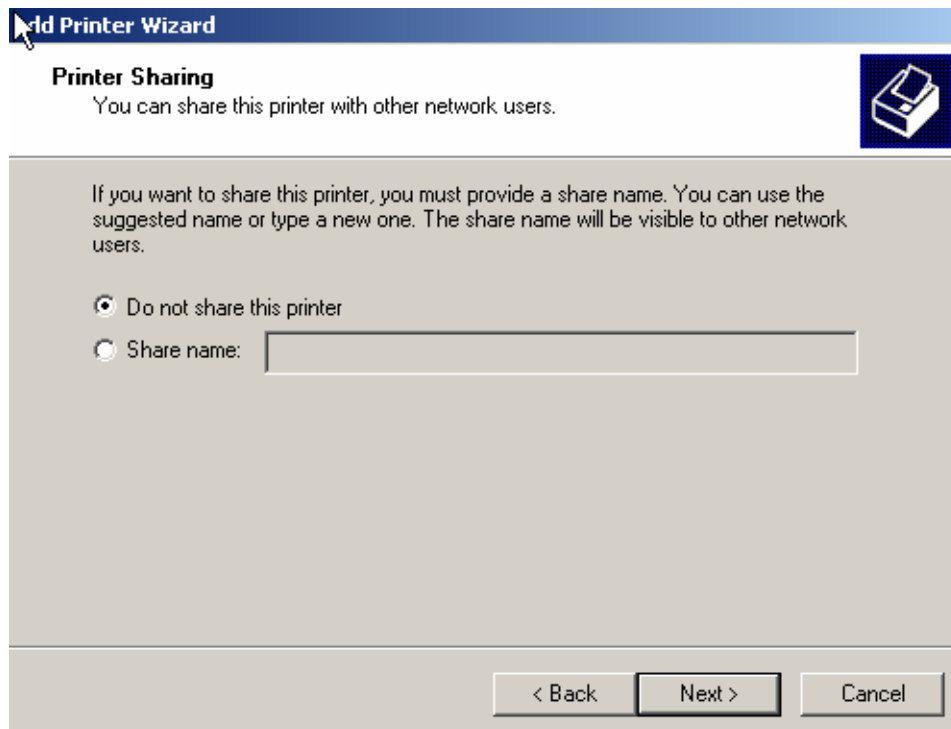

12) Select Next

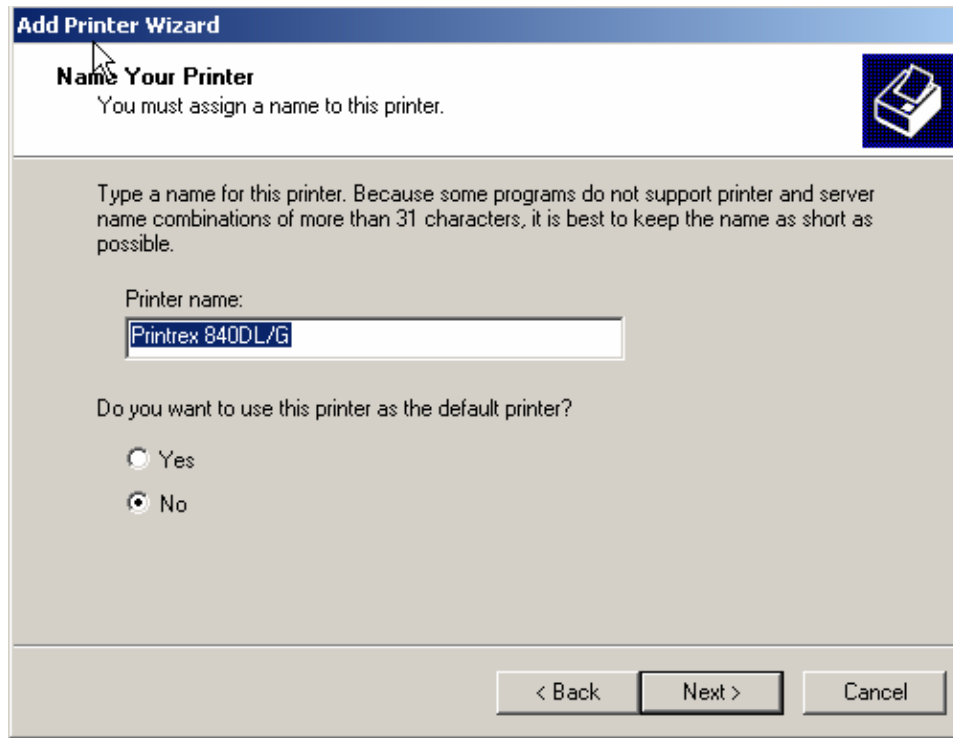

13) Select Next

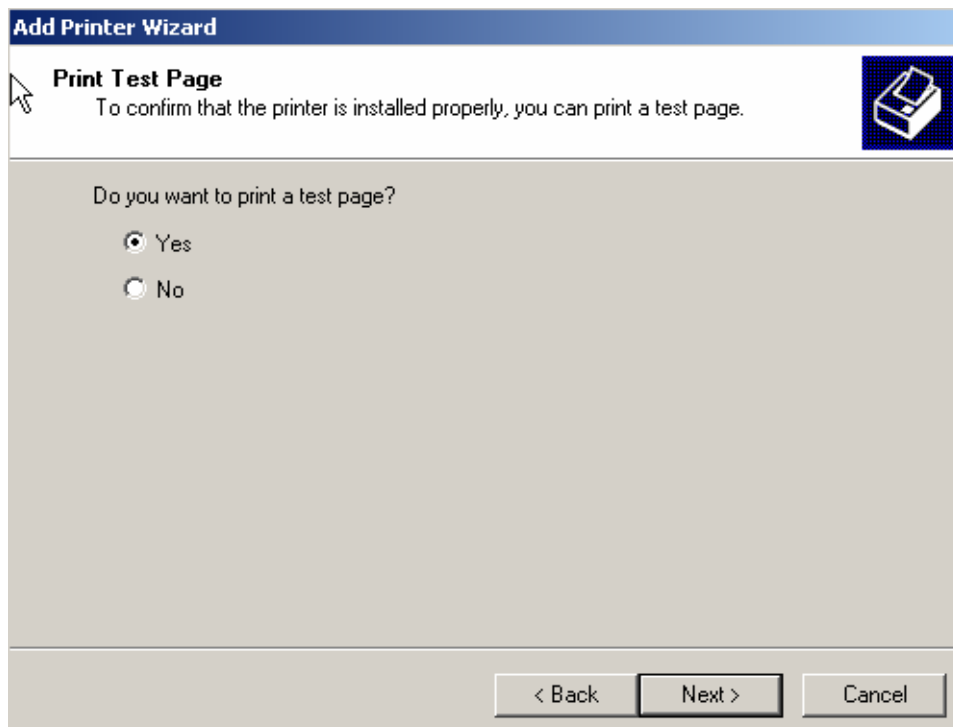

14) Select Next

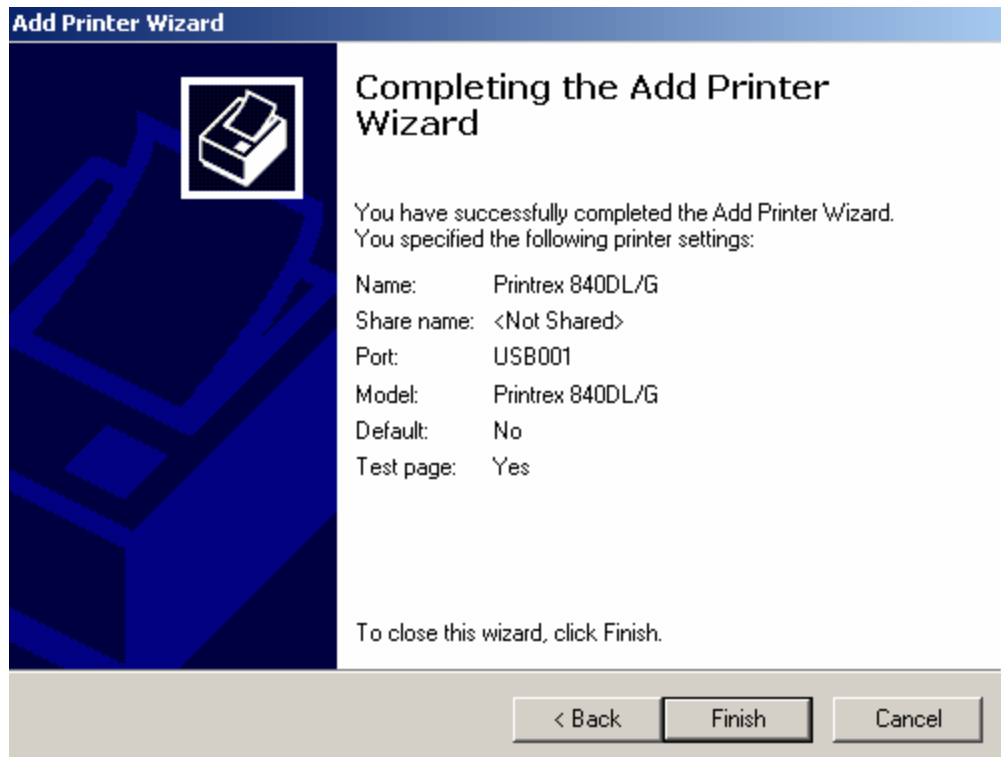

15) Select Finish

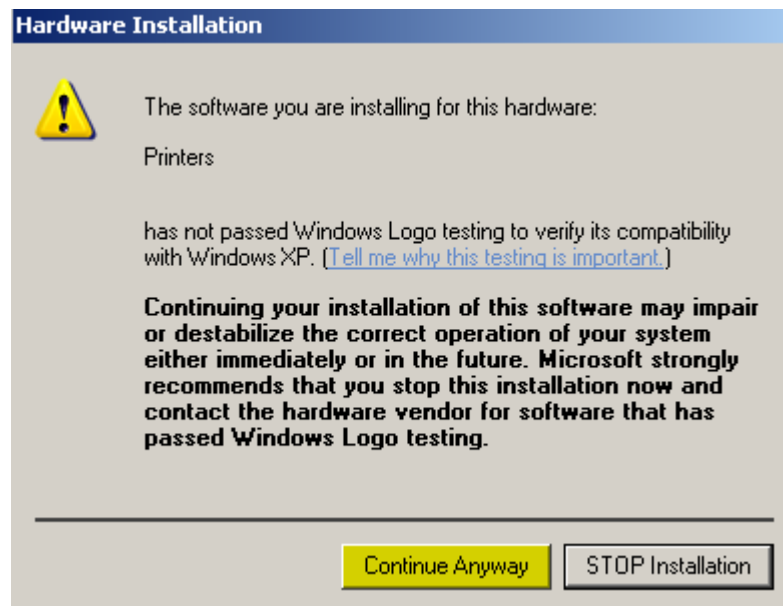

16) Select Continue Anyway

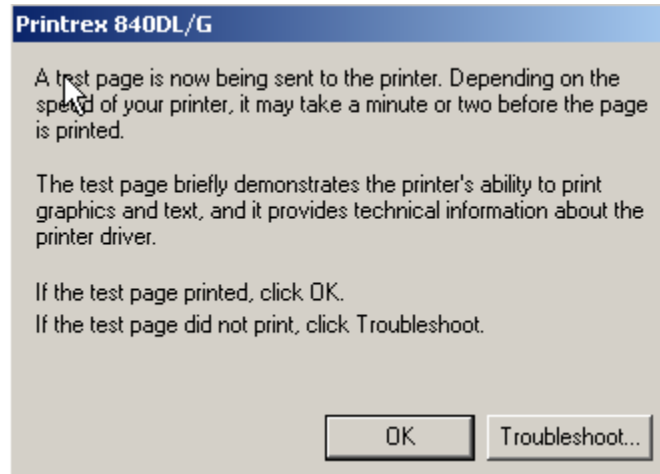

17) The Printer Test Page must appear. At this point, the Printer is installed in windows XP. Click OK.

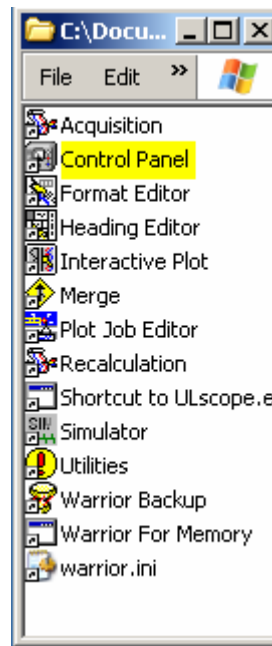

18) To install the Printer in Warrior, select the Control Panel option.

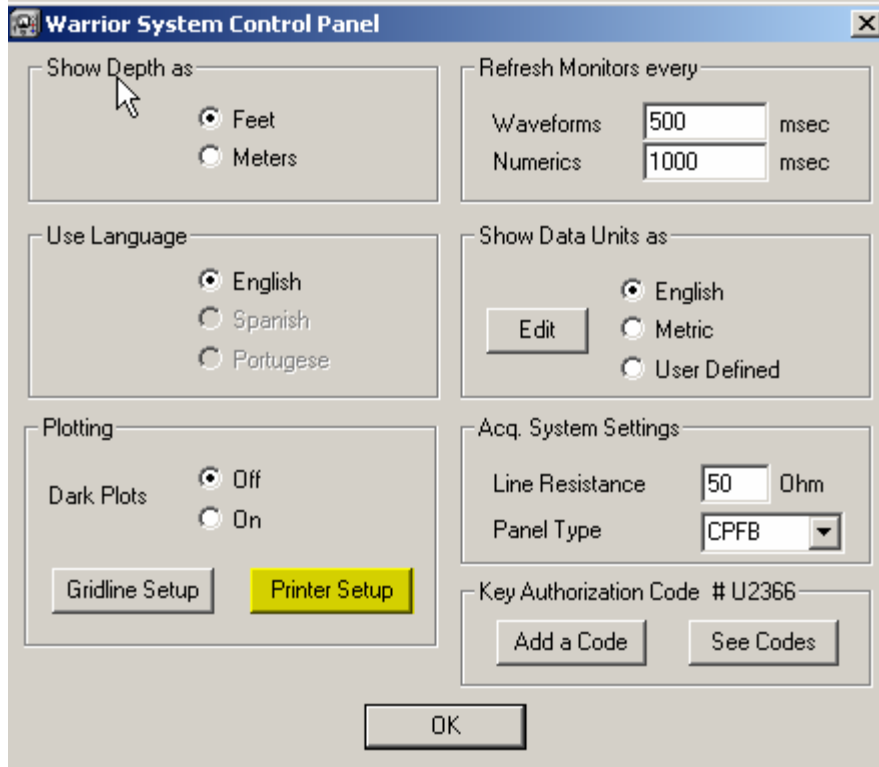

19) Select Printer Setup

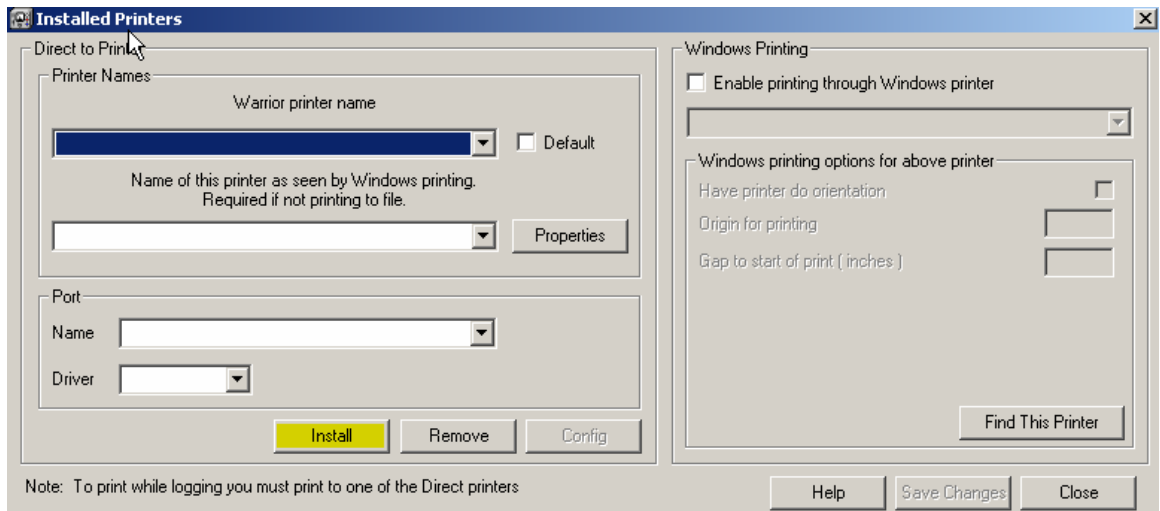

20) Select Install

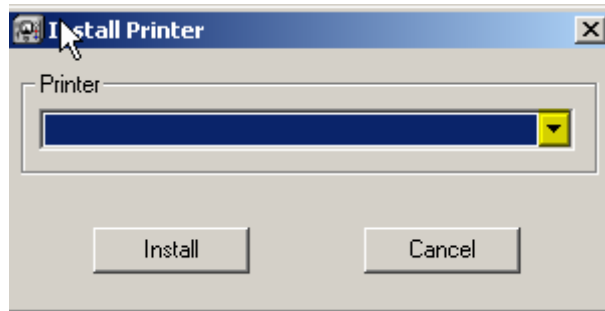

21) Select the option Printrex click on Drop-down

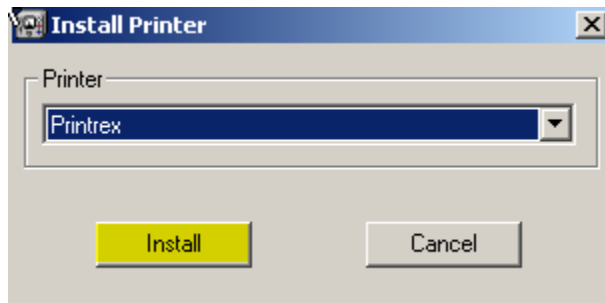

22) Select Install

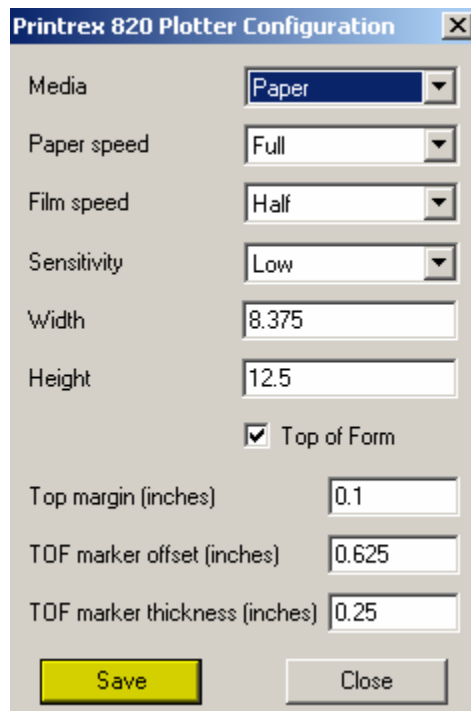

23) Select Save

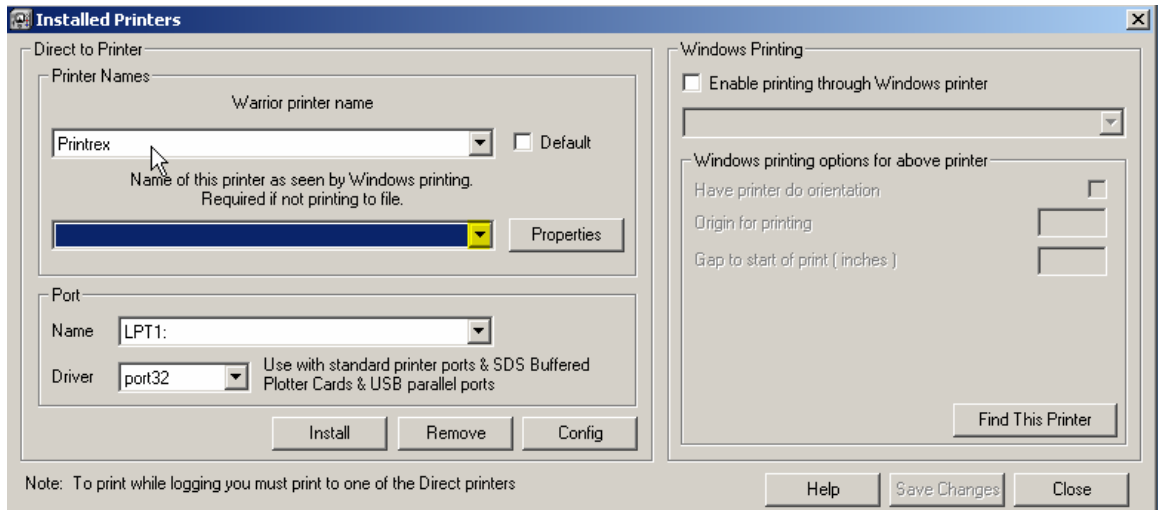

24) On the Drop-down, select Printer Model Printrex 840DL/G

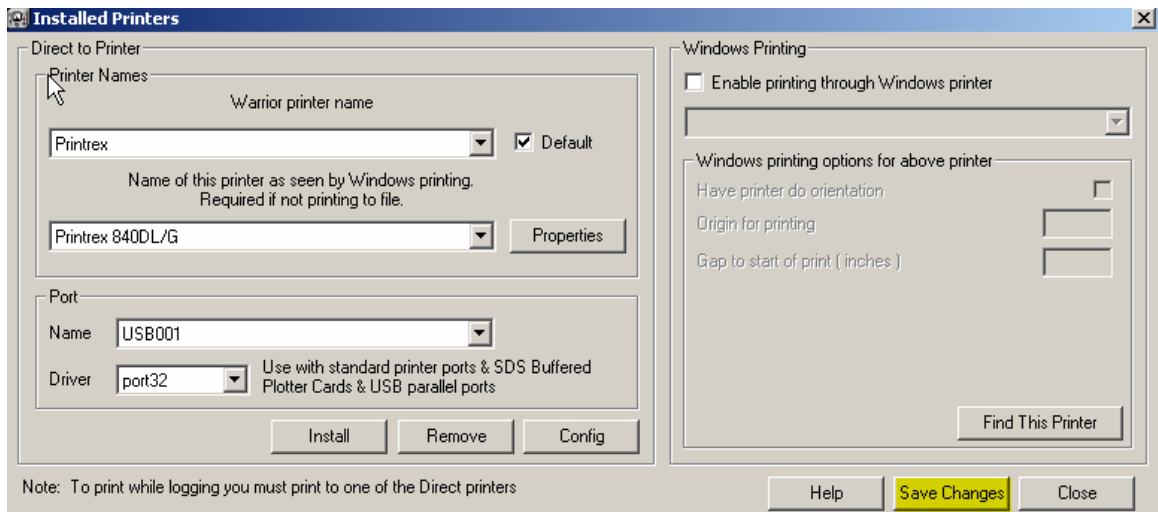

25) Select Save Changes and Close

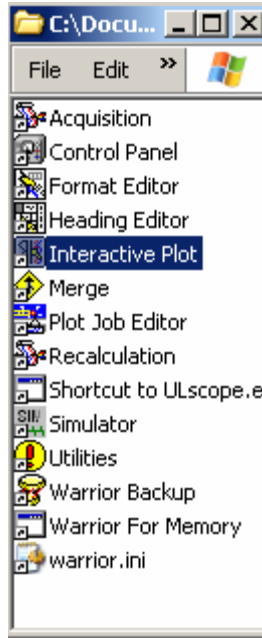

26) Select Interactive Plot in order to test the Print Out



27) Select Action



28) Select Hardcopy

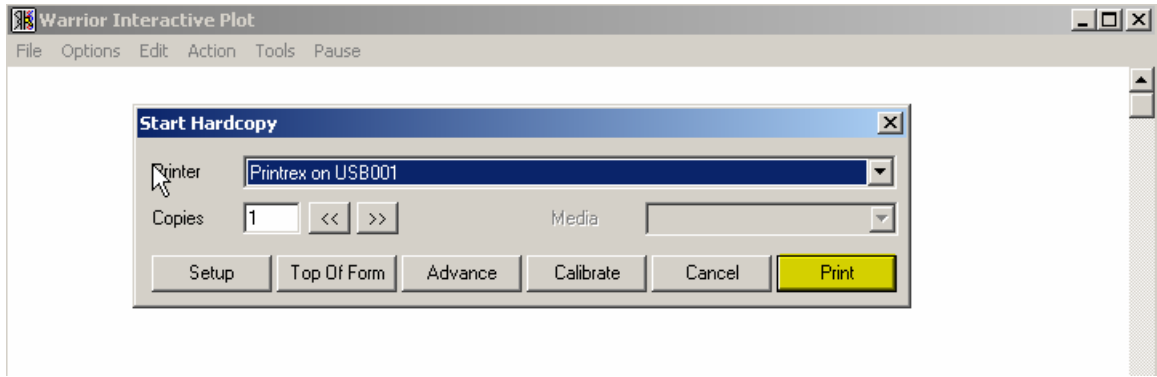

29) Select Print

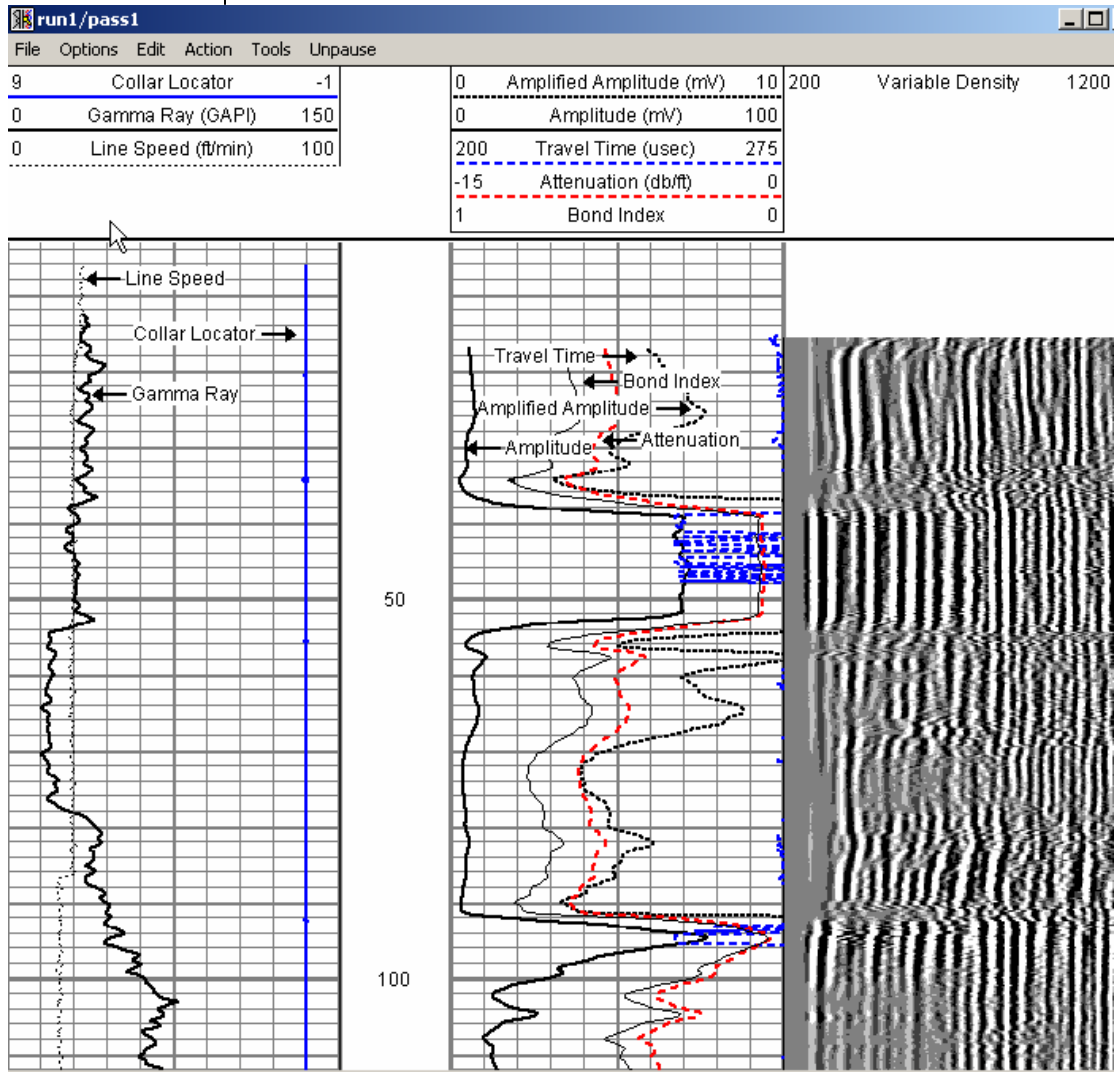

Finding Printer

We recommend connecting the Printer/Plotter in the same USB port. If you do not know which port is, start the following procedure:

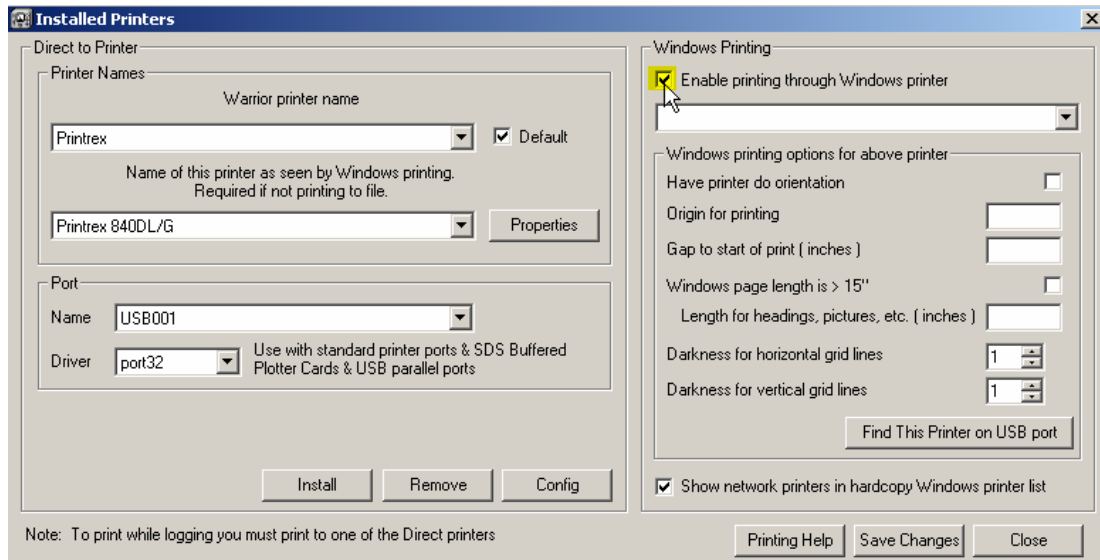

Installed Printers

Check Enable printing through Windows Printing.

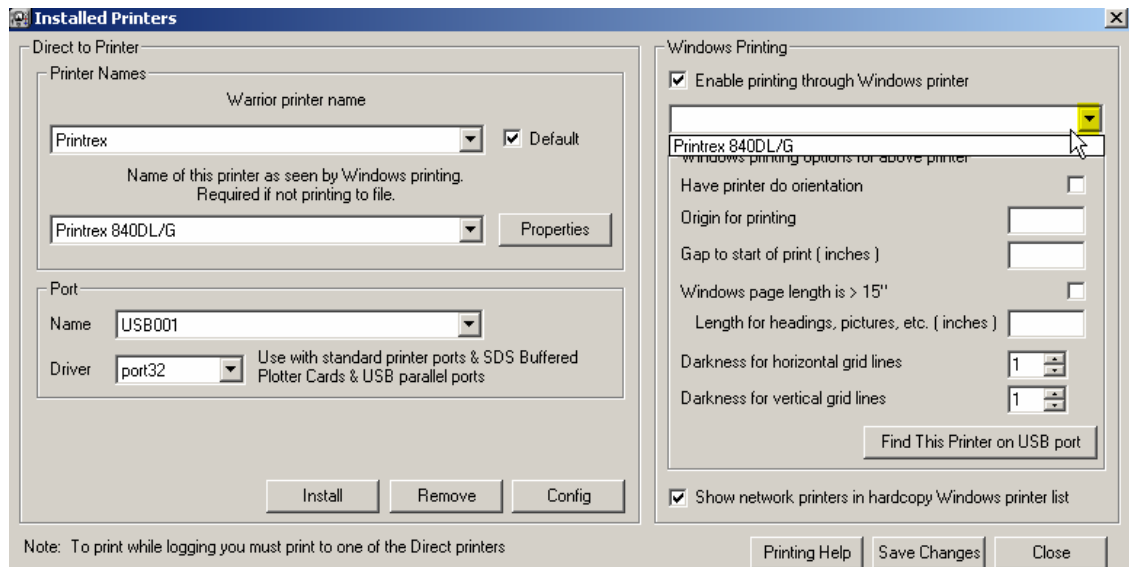

Installed Printers

On the Drop-down, Select Printer Model Printrex 840DL/G

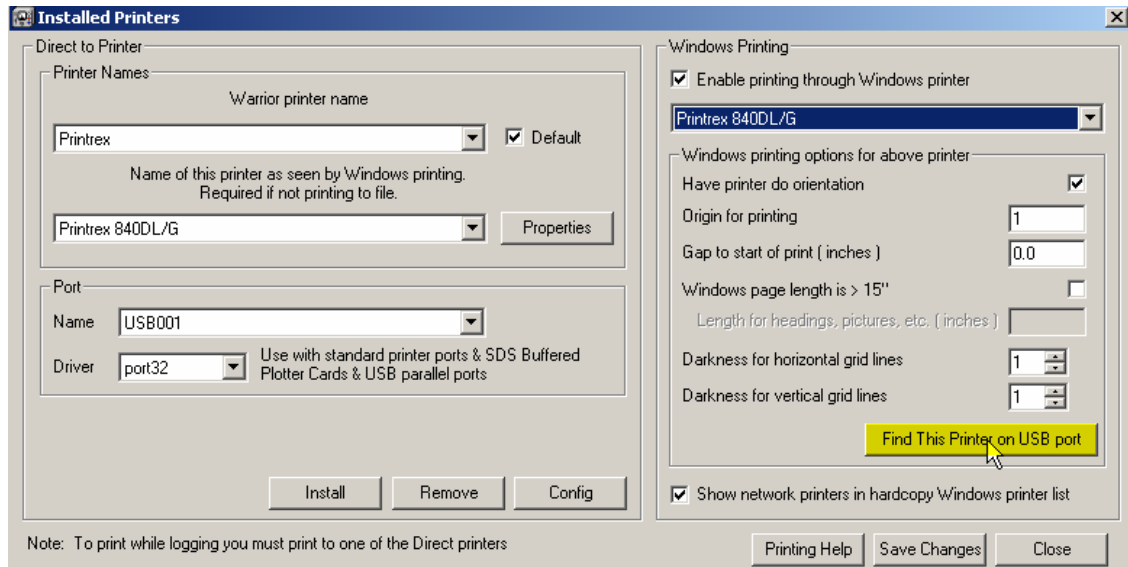

Installed Printers

Select Find this Printer on USB port.

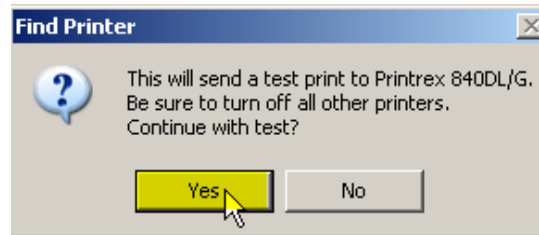

Find Printer

Select Yes

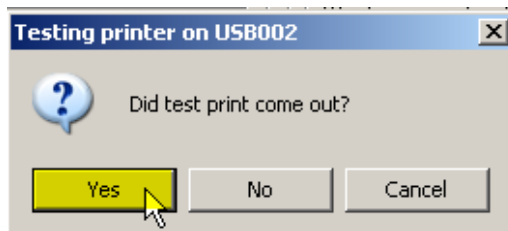

Testing Printer

If the test print came out, select Yes. This means the printer is connected to USB002



Printer Found

Select OK

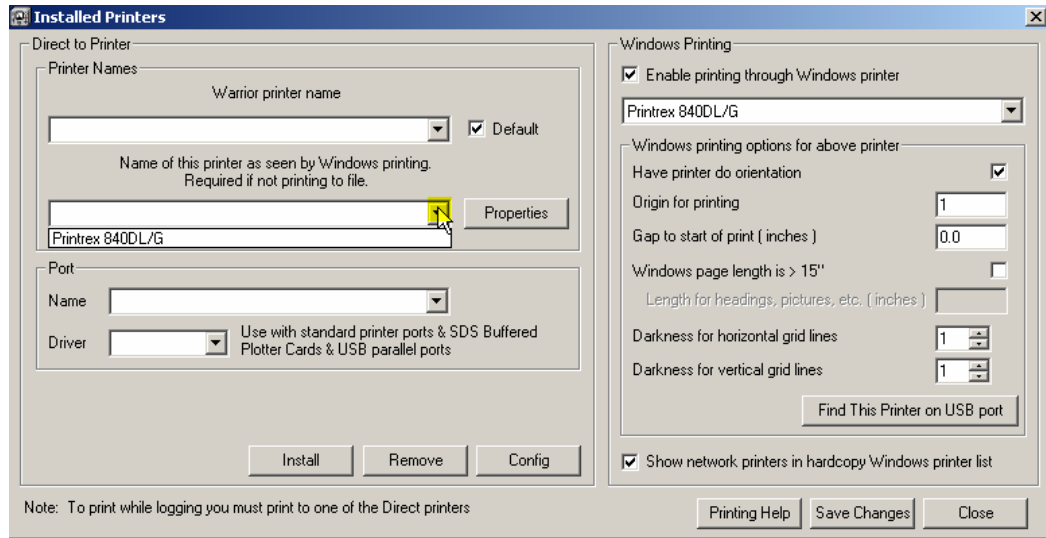

Installed Printers

On the Drop-down Select Printer Model Printrex 840DL/G

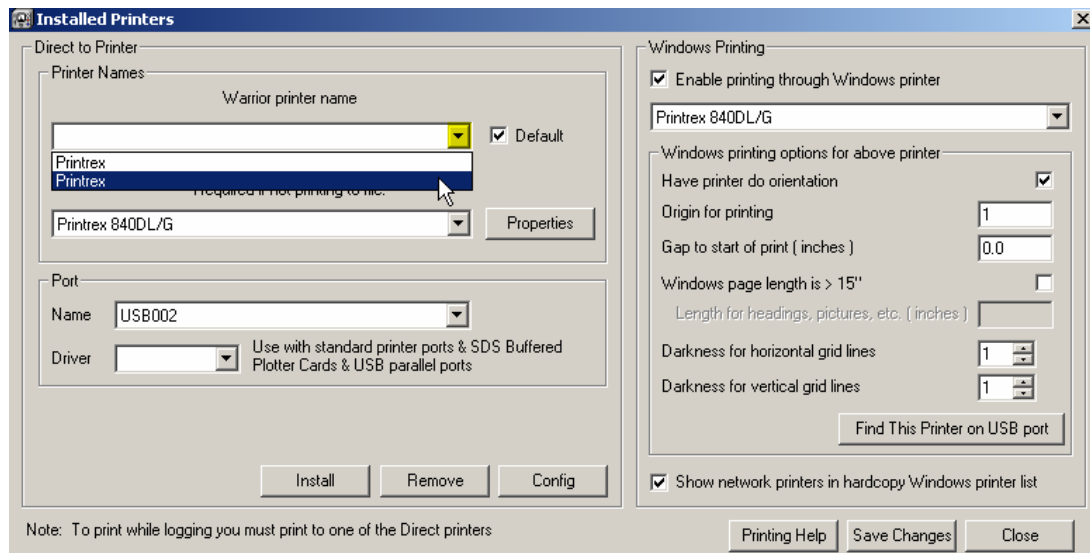

Installed Printers

On the drop-down select Printrex

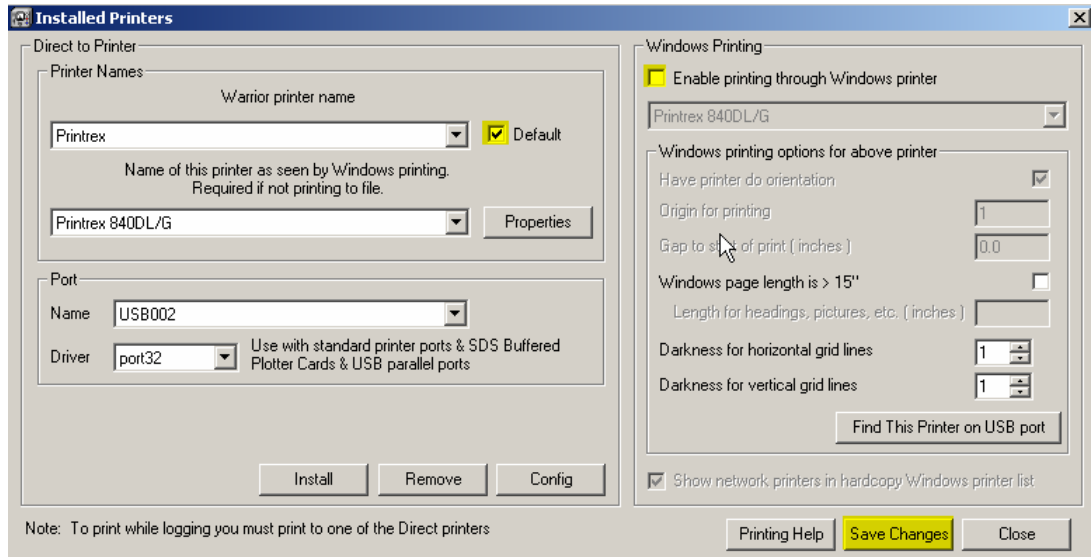

Installed Printers

Uncheck Enable printing through Windows printer and then select Save Changes